

Scala 1:2 misure espresse in mm

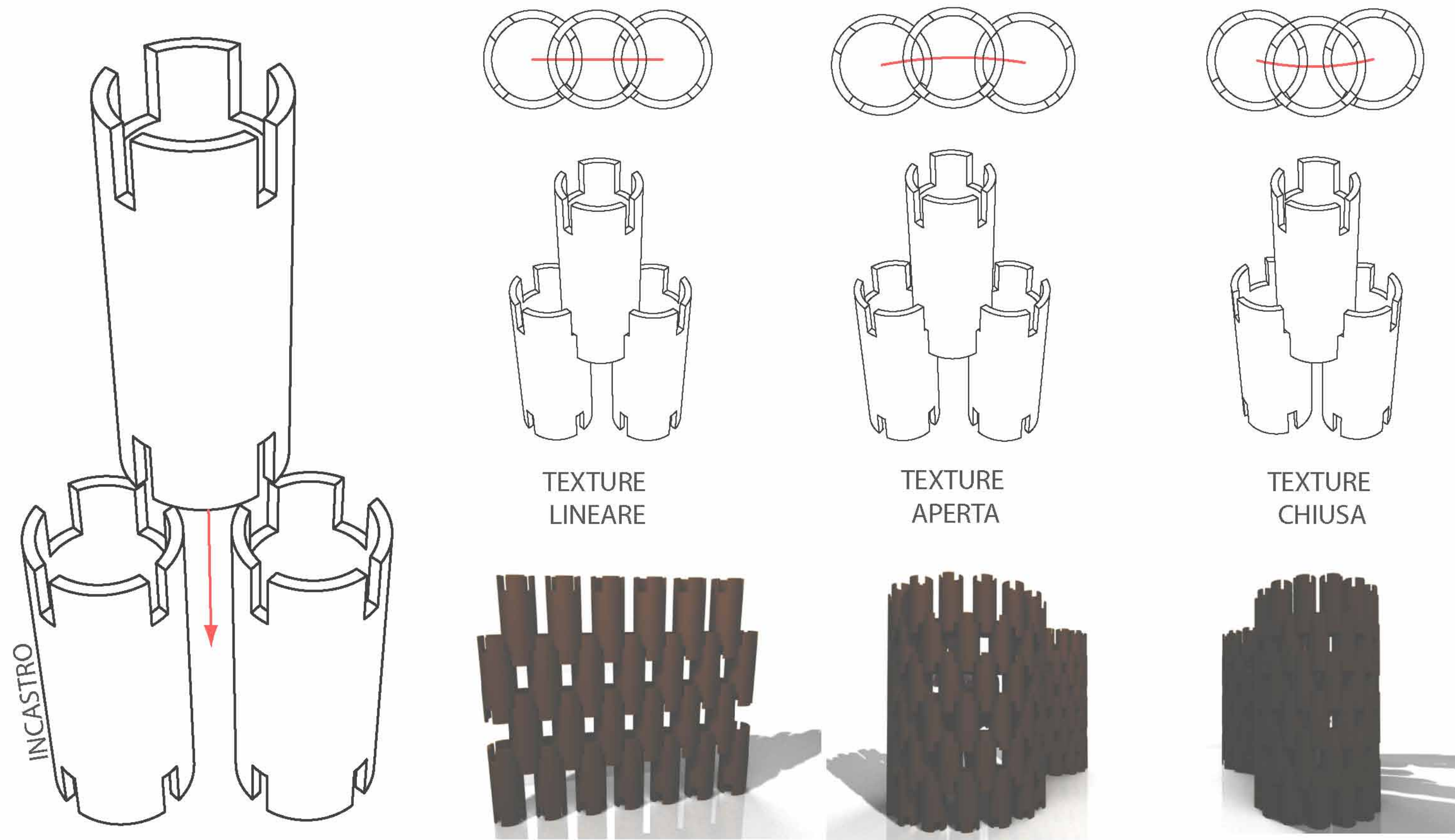

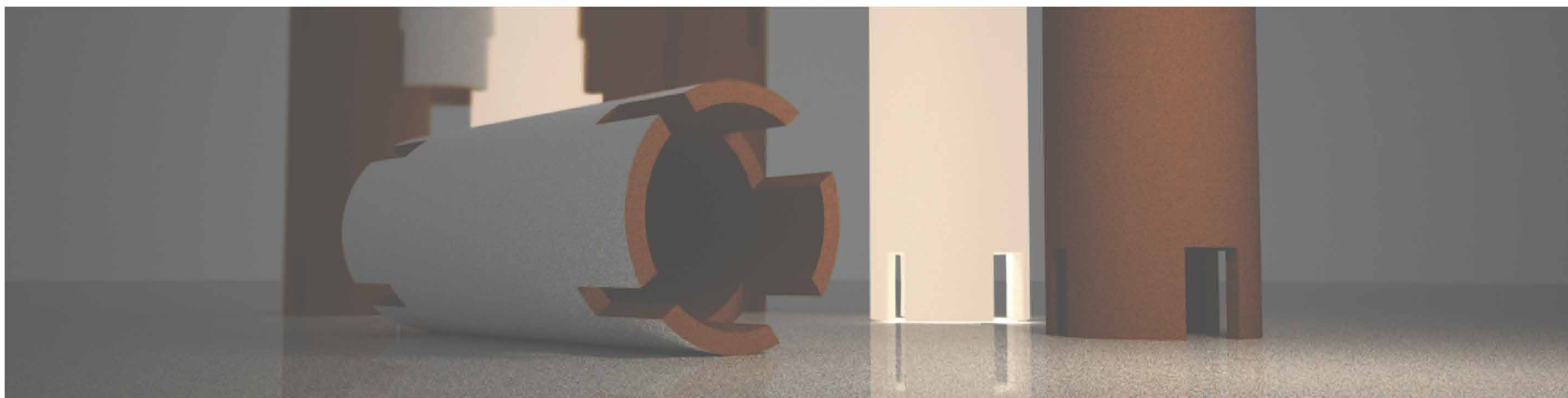

L'incastro permette, grazie ai tagli posteriori di 5 cm, una torsione rispetto all'asse del tubo, tenendo come perno il taglio da 2,5 cm. Questo particolare incastro consente quindi di posizionare i tubi a proprio piacimento creando anche delle barriere con pianta curva. In base a come si posizionano i moduli si modifica anche l'apertura dell'incastro.



UNICAM  
Università  
di Camerino  
  
2007.2008





Prospetto FRONTALE

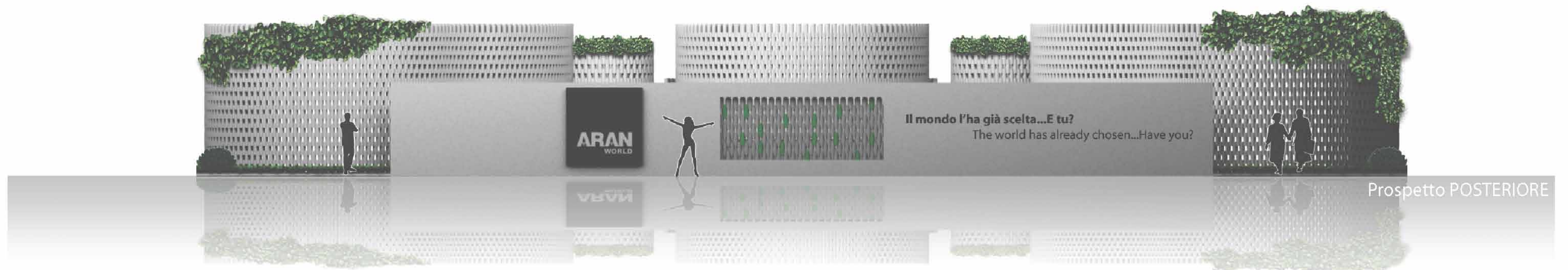

Prospetto POSTERIORE

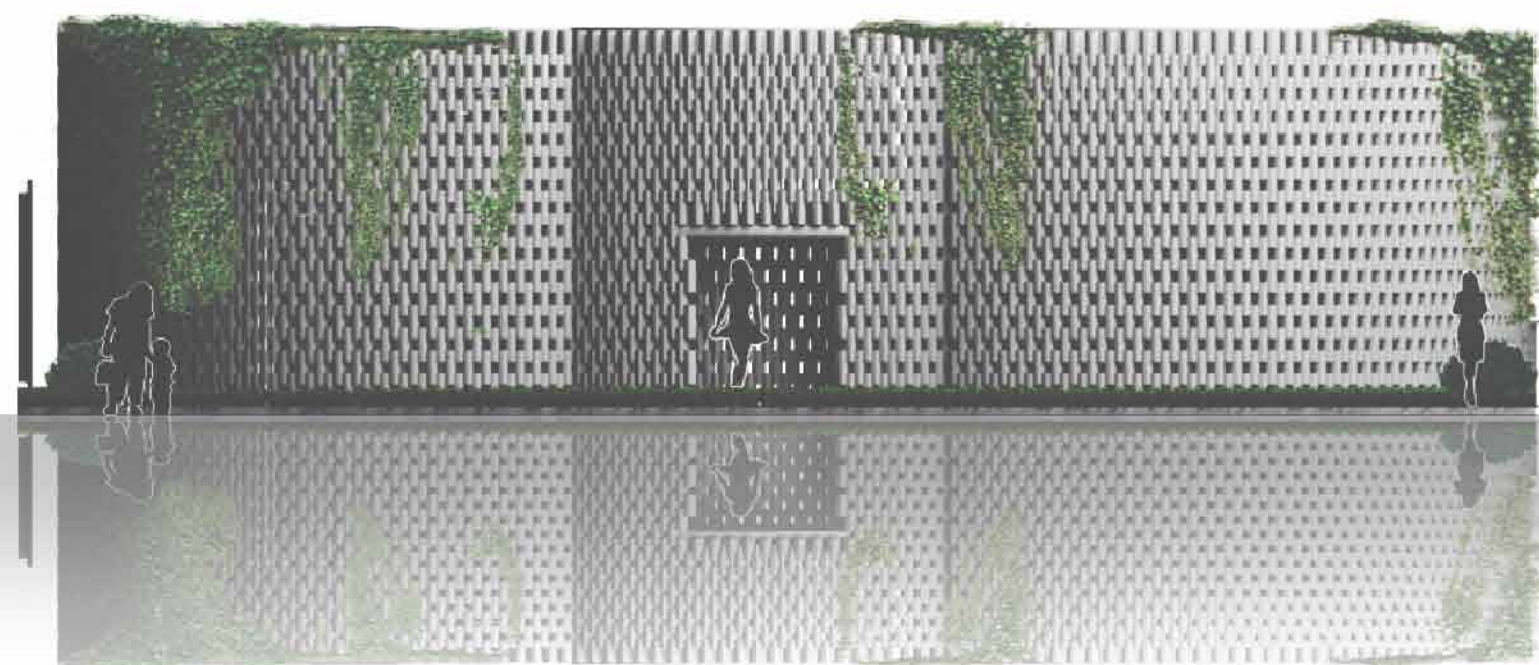

Prospetto LATERALE

UNICAM  
Università  
di Camerino

2007.2008



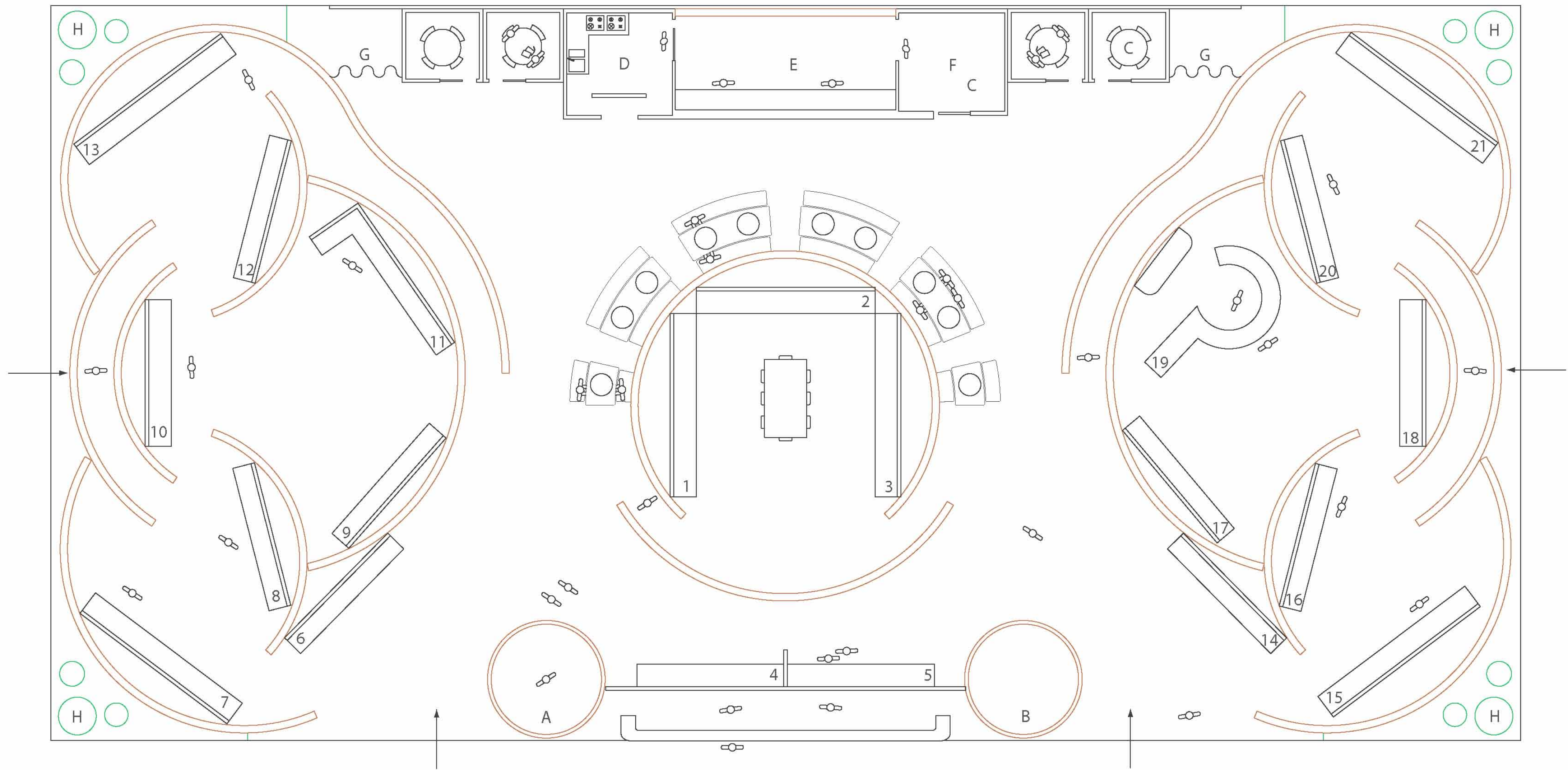

PARETI COMPOSTE DA MODULI 

PARETI LAMELLARI AUTOPORTANTI 

1,2,3 Cucine linea "TRADITIONAL"  
 da 4 a 21 Cucine linea "CONTEMPORARY"

- A Guardaroba
- B Magazzino Cataloghi
- C Uffici
- D Cucina
- E Bar
- F Magazzino Bar
- G Uscite di Sicurezza
- H Zone verdi



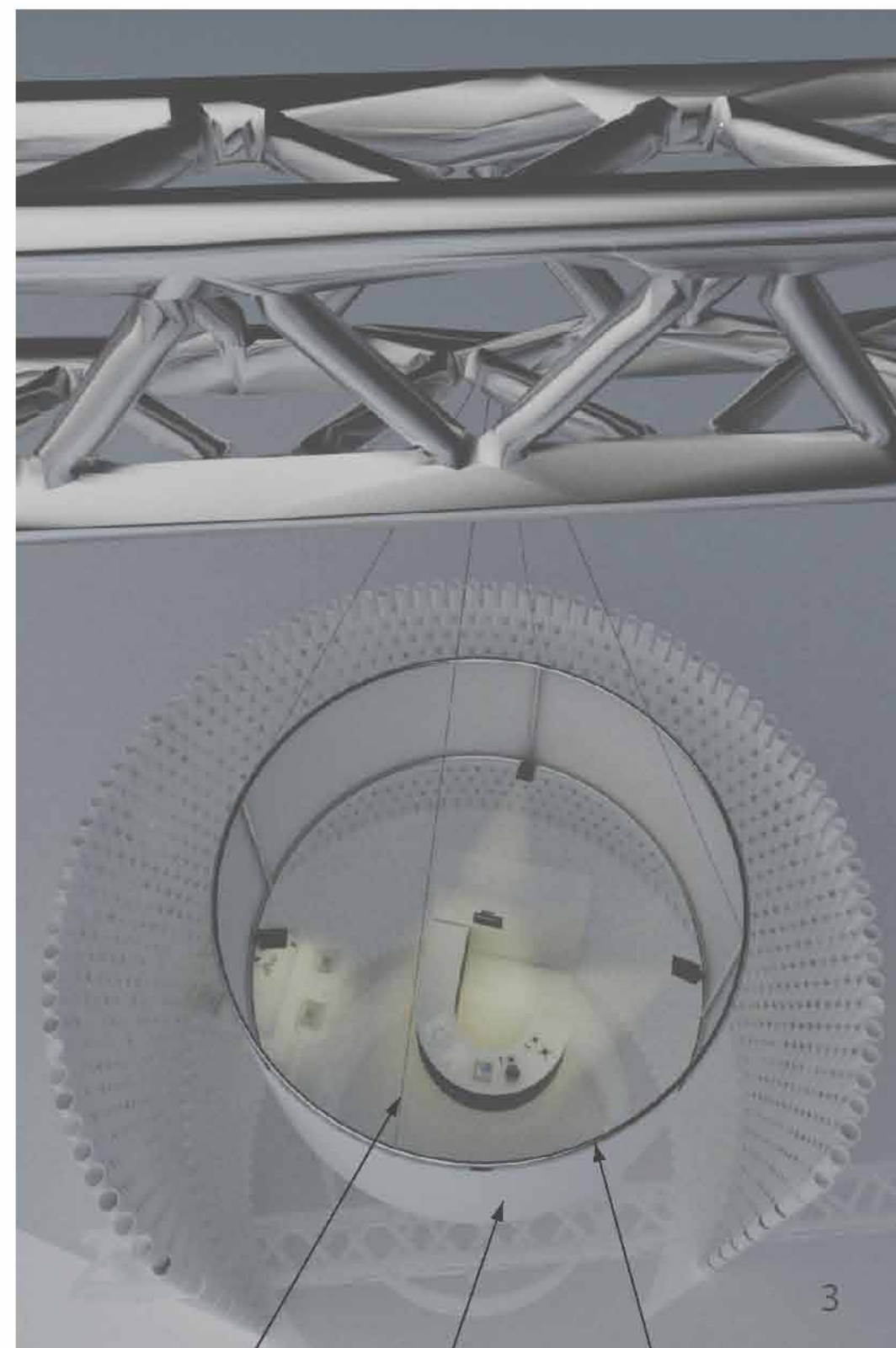
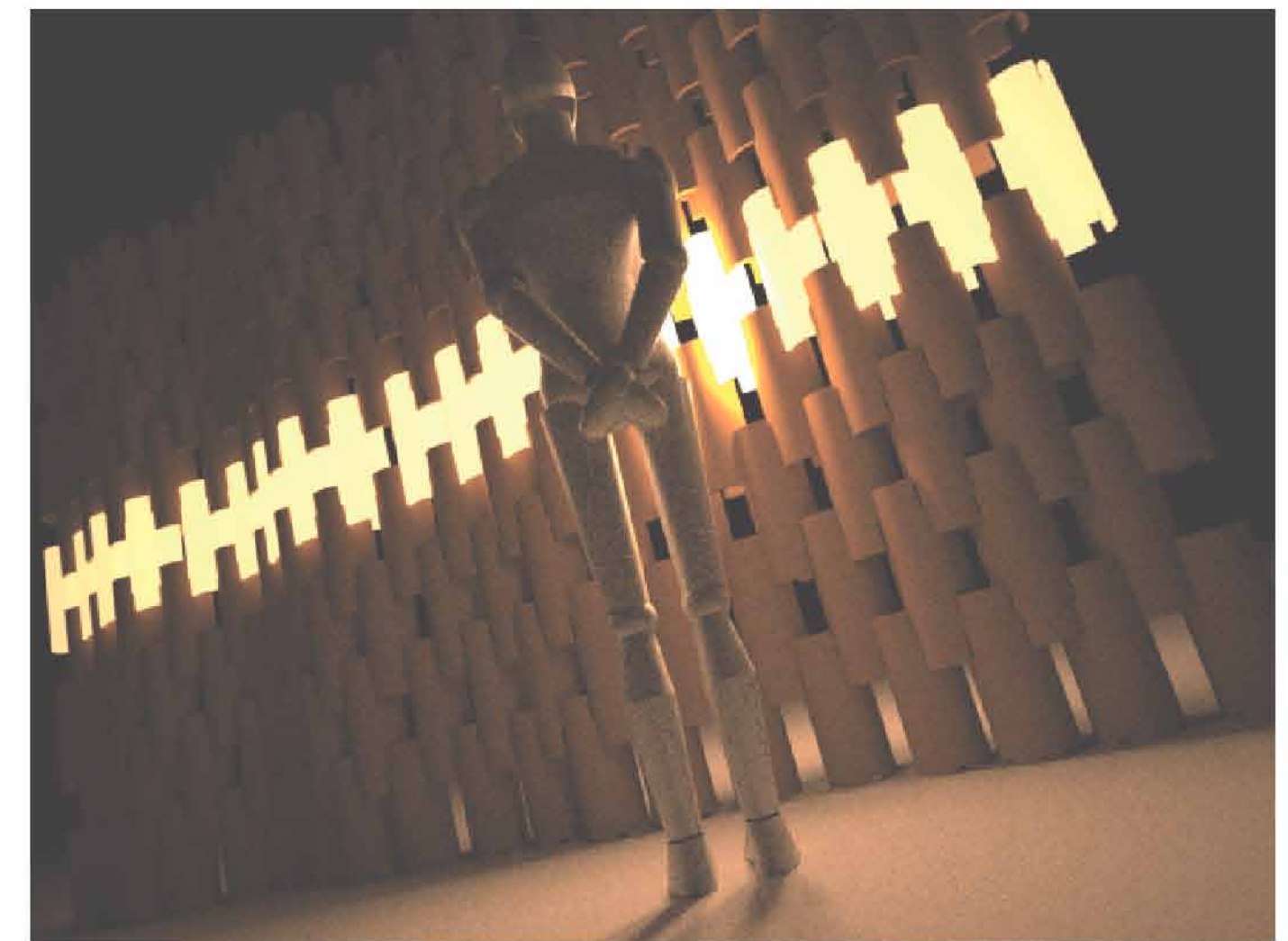
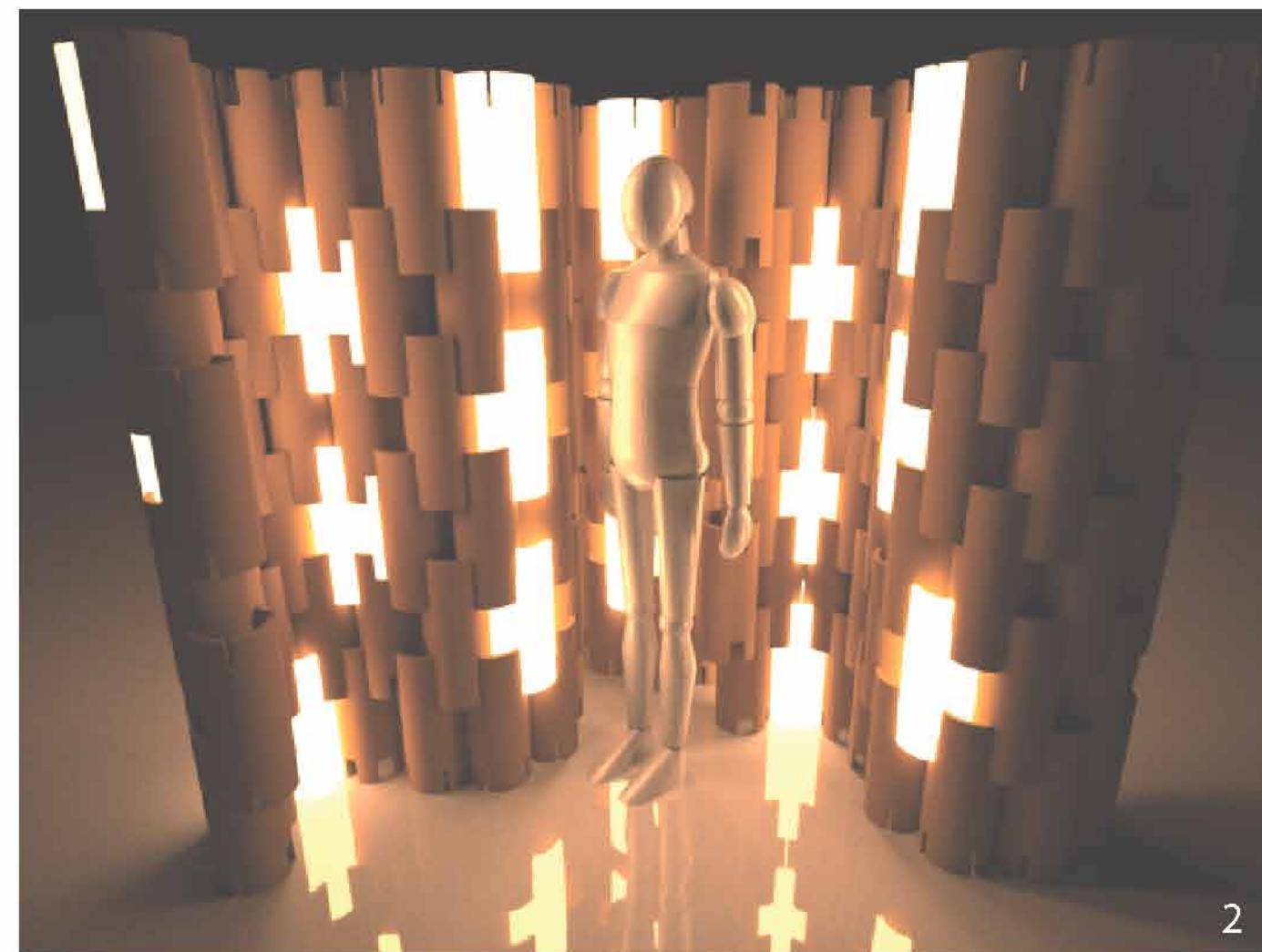

Cavo acciaio Telo cotone Tubolare metallico  $\varnothing$  50 mm

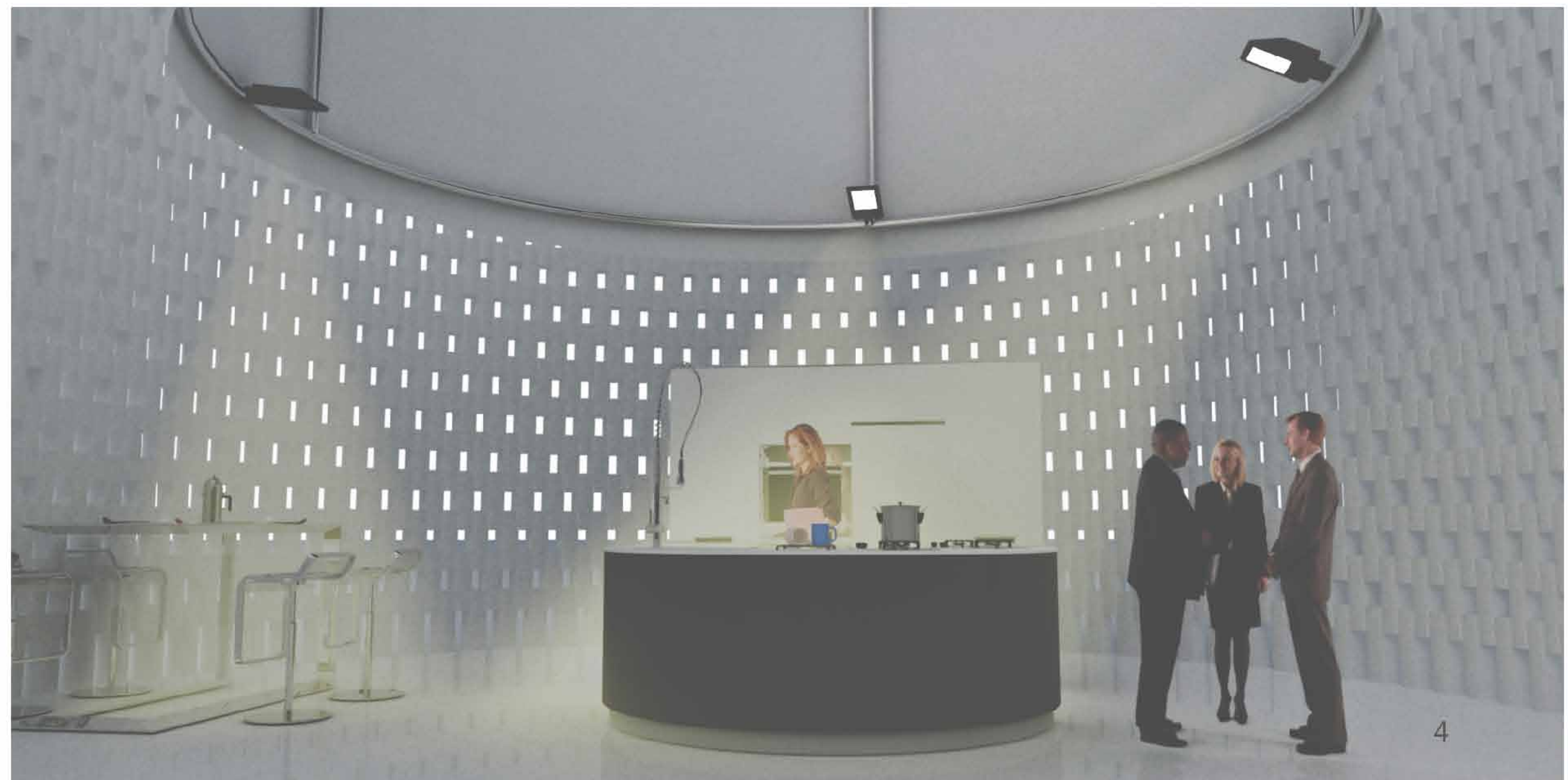

L'illuminazione prevista per lo stand espositivo è di due tipologie. Quella scenografica è resa possibile grazie ai moduli di polietilene (1) che, integrati agli altri moduli di cartone, rendono all'ambiente una illuminazione "soft"(2). L'illuminazione dedicata ad esaltare i prodotti, invece, è nascosta da delle strutture in tubolare d'acciaio, coperte da un telo di cotone. Queste strutture sono appese alle americane strutturali dello spazio fiera dedicato tramite dei cavi in acciaio (3). Su queste strutture sono montati dei fari alogeni rivolti sui prodotti che si vogliono esaltare(4).

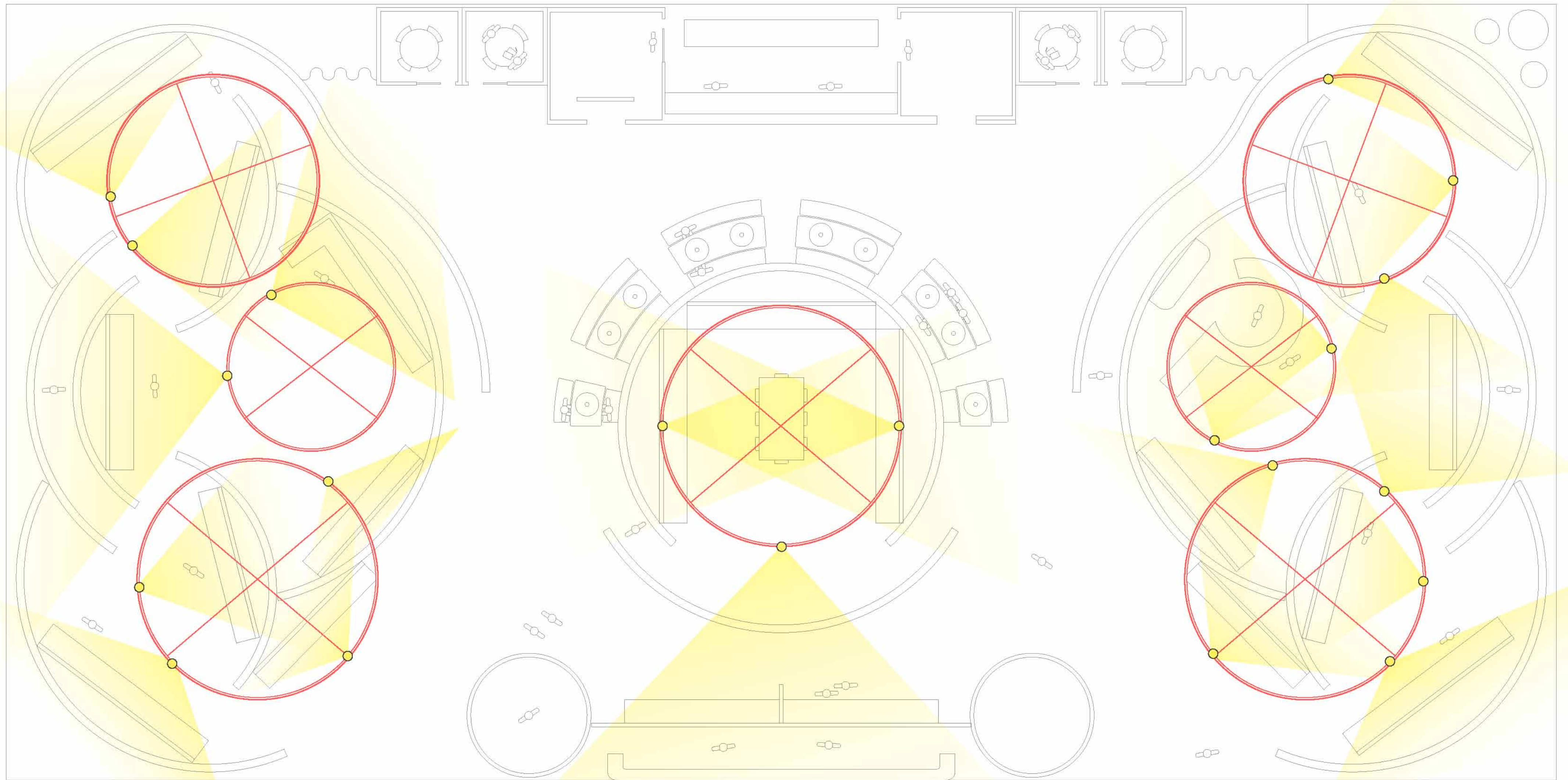

UNICAM  
Università  
di Camerino

2007.2008



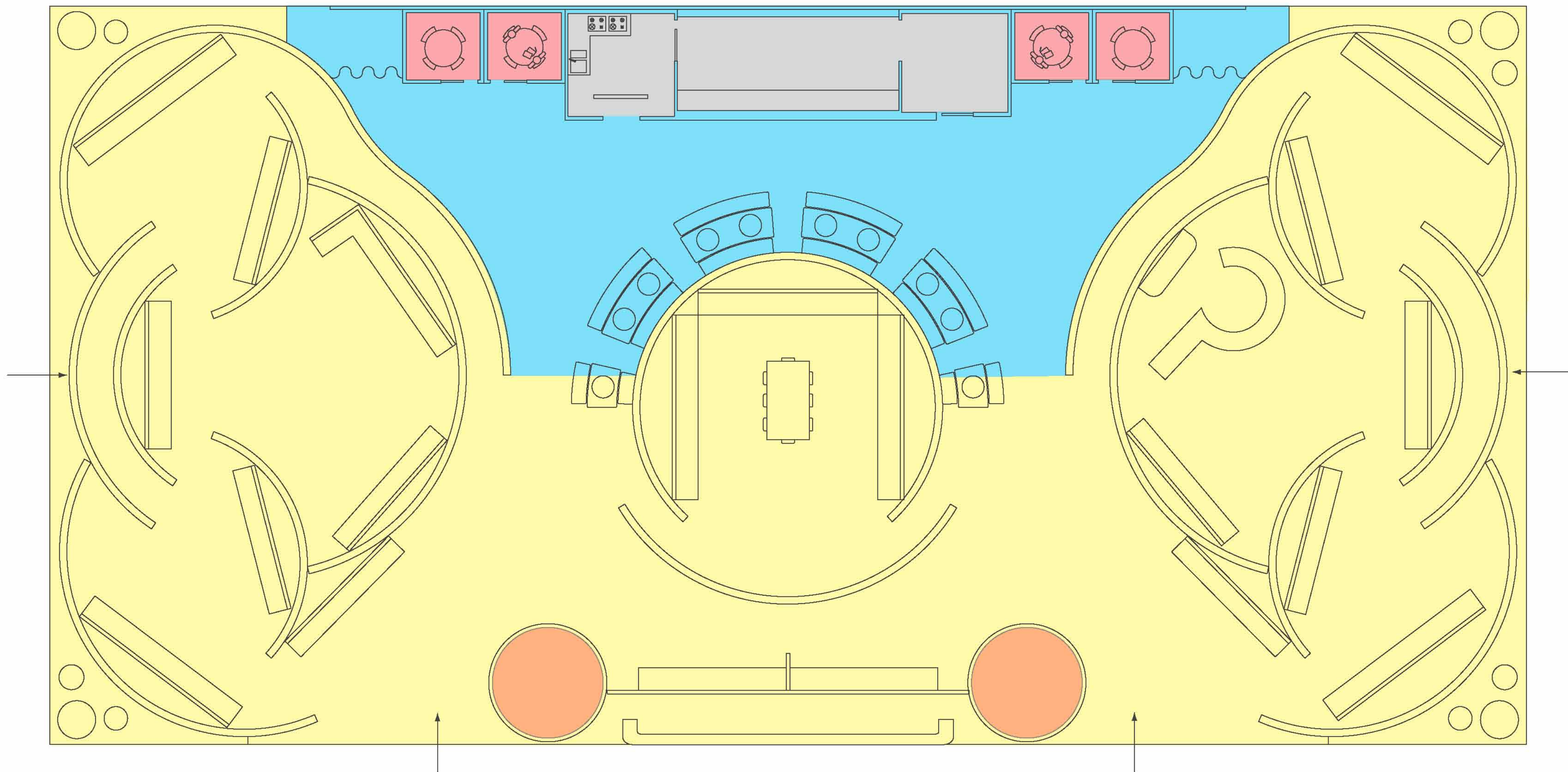

ZONE ACCESSIBILI  
DA TUTTI

ZONA  
RECEPTIONISTI

ZONA  
OPERATORE  
RISTORAZIONE

AREA RISERVATA

ZONE OPERATORE  
COMMERCIALE

UNICAM  
Università  
di Camerino  
2007.2008



# ARAN WORLD



UNICAM  
Università  
di Camerino

2007.2008





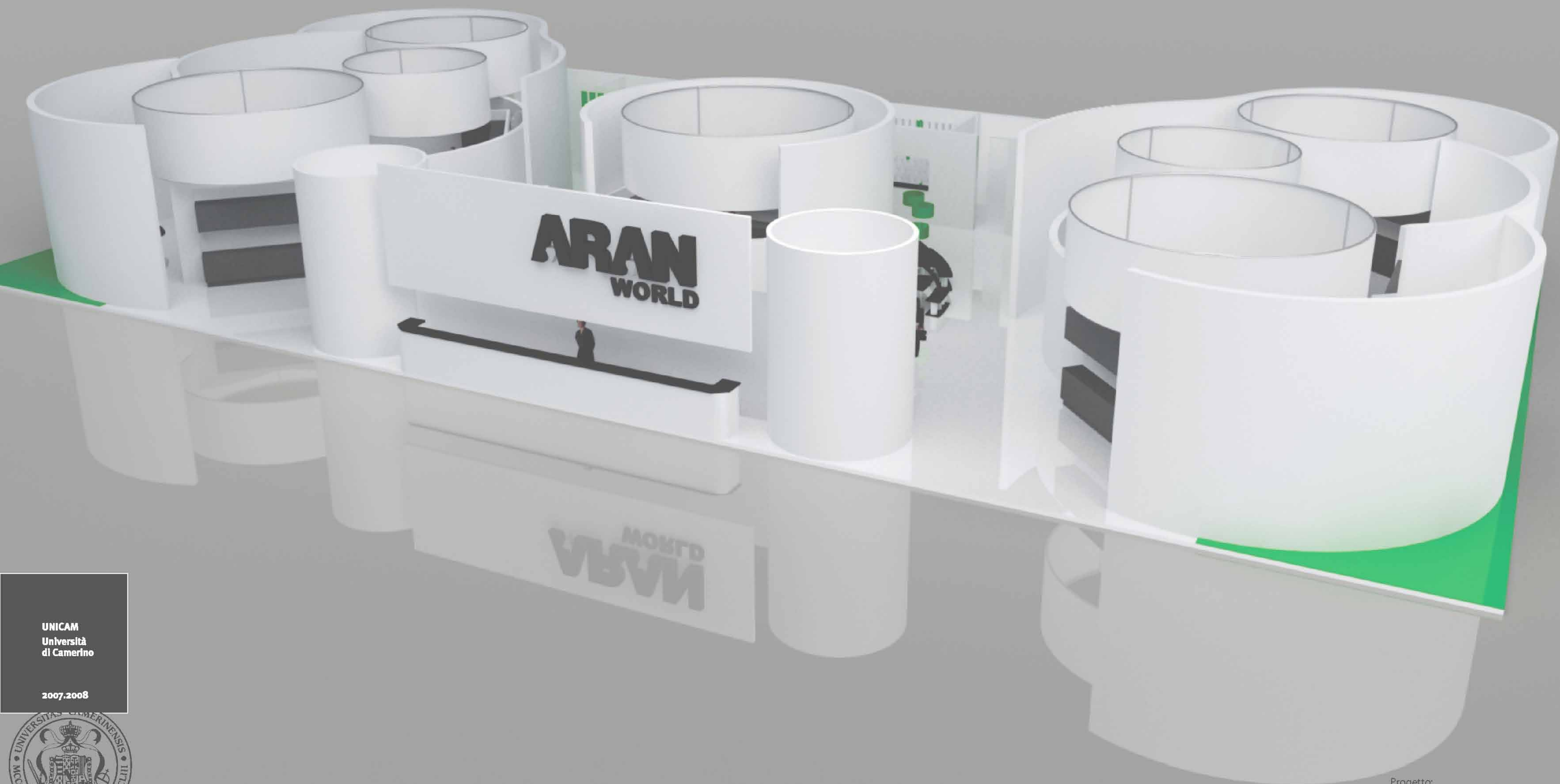

UNICAM  
Università  
di Camerino

2007.2008



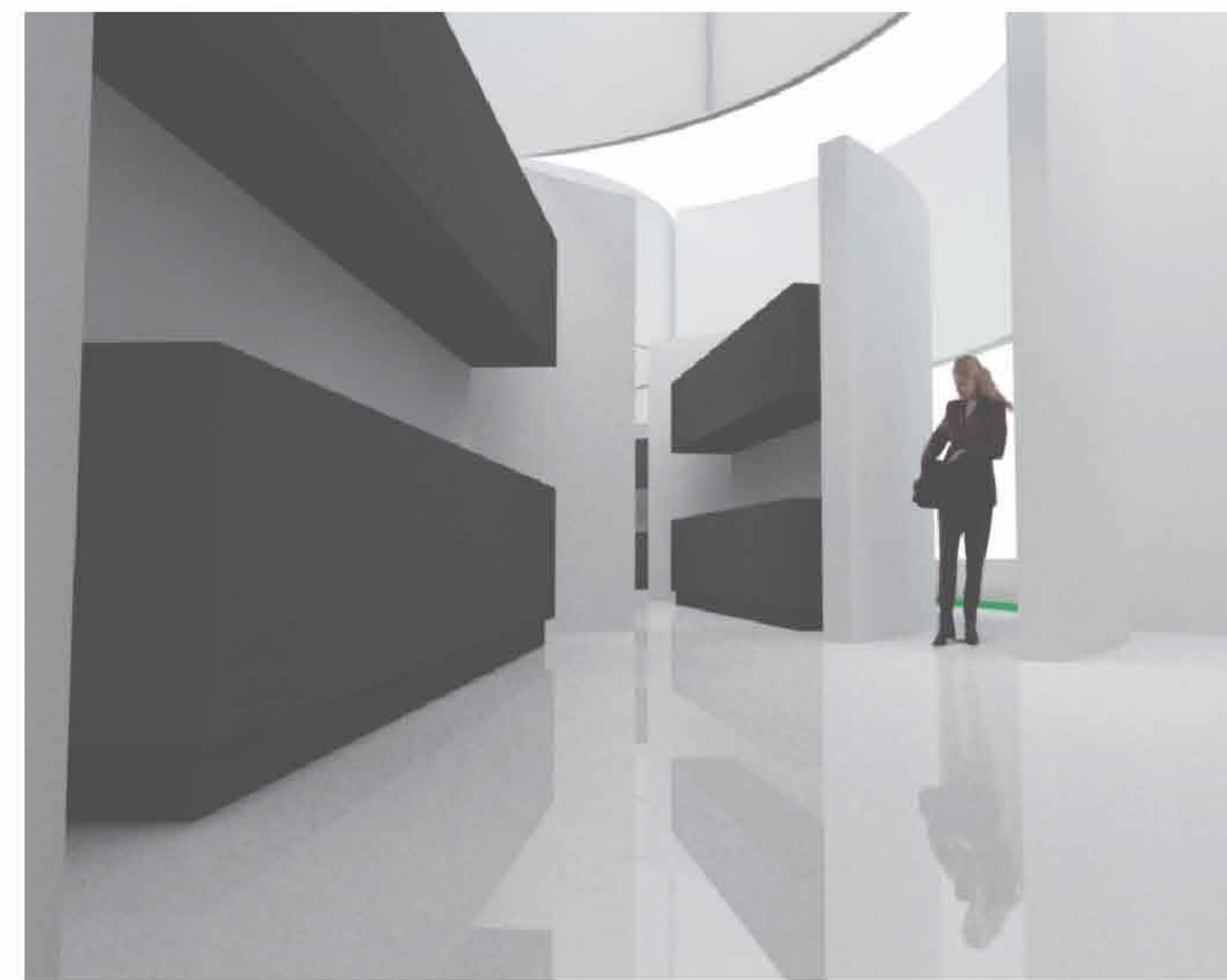
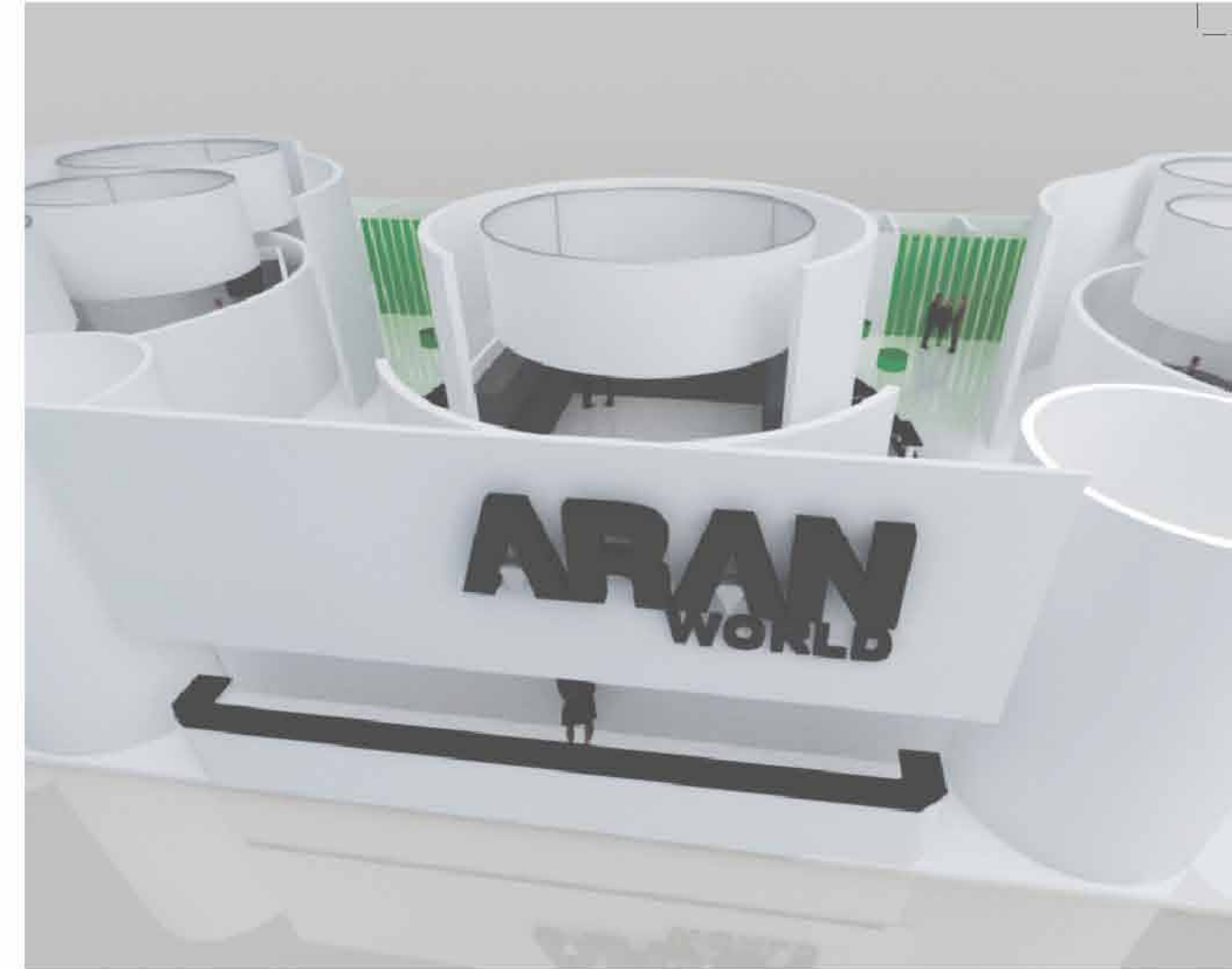
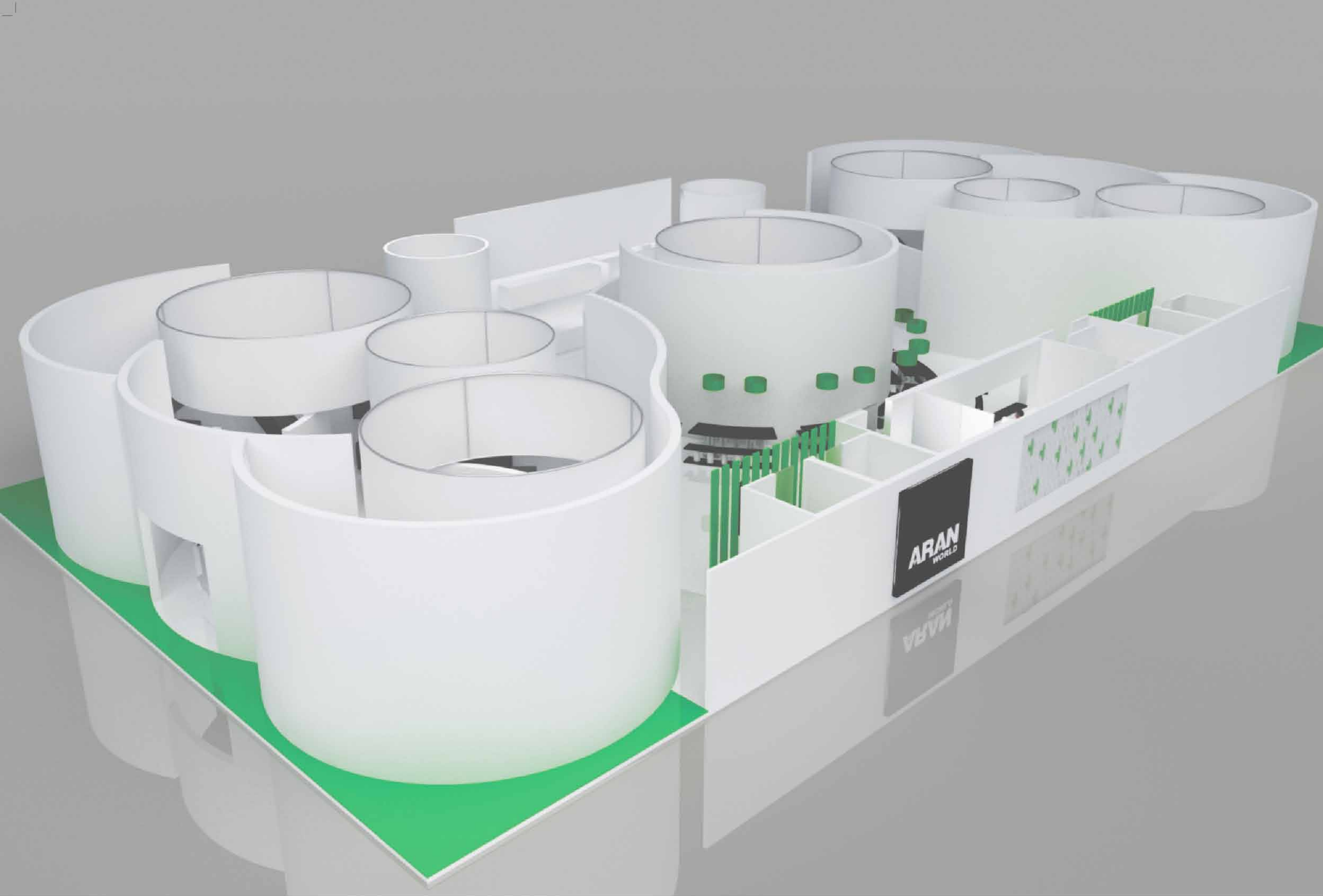

UNICAM  
Università  
di Camerino  
2007.2008

