

# Bioplastica da fondi di caffè

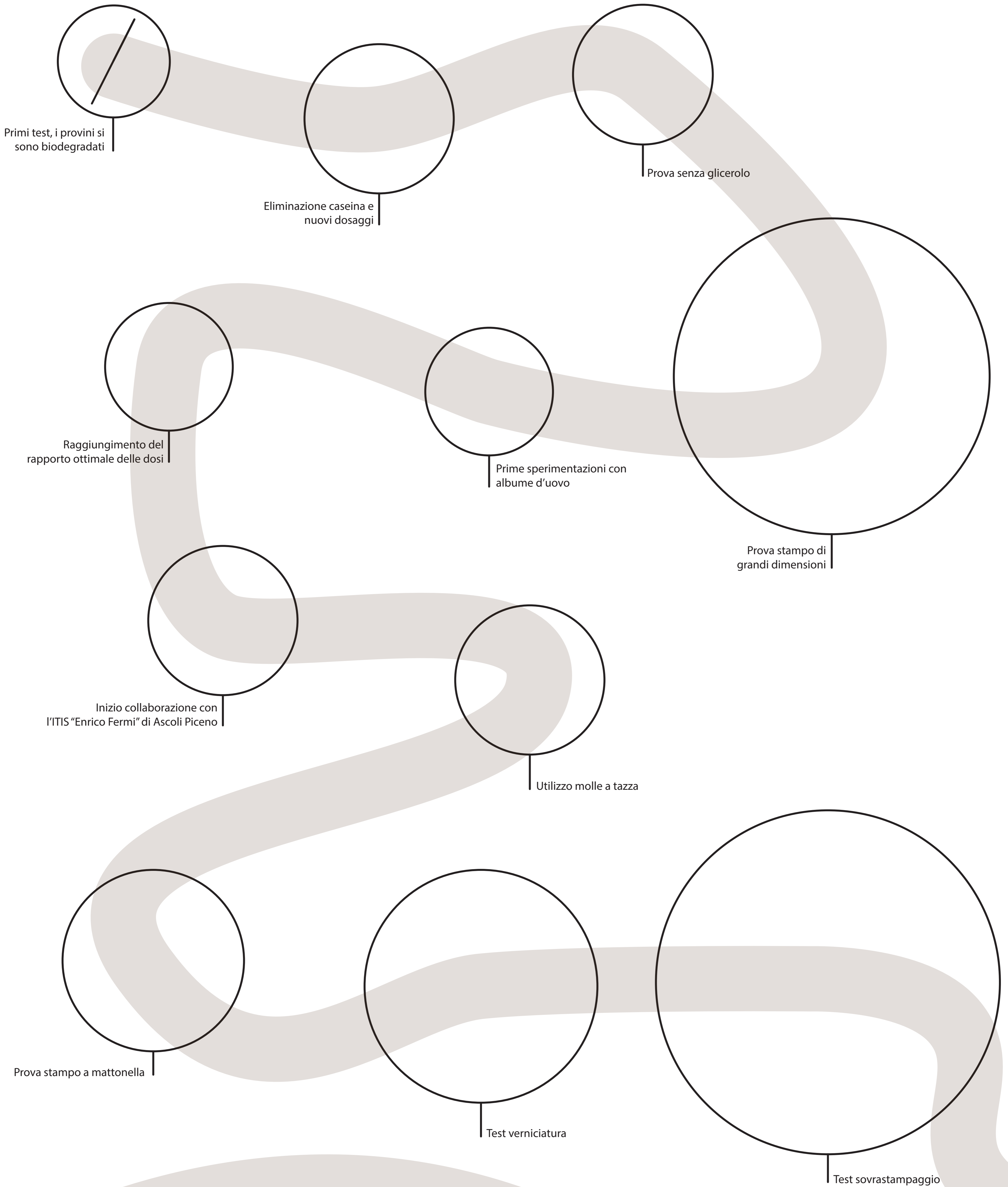



# Bioplastica da fondi di caffè

**ALCAFFÉ**

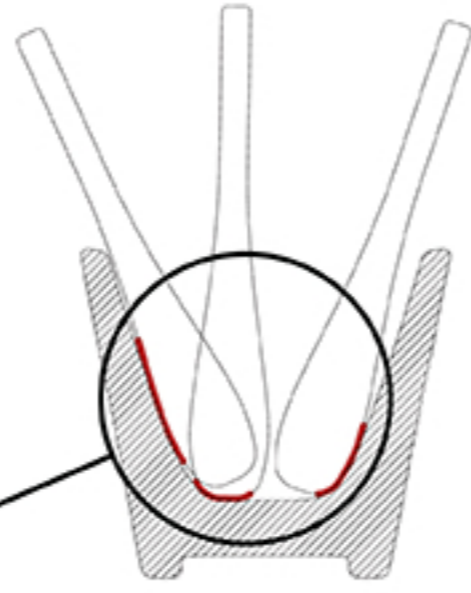

Profilo sagomato per adattarsi alla curvatura interna della tazzina.

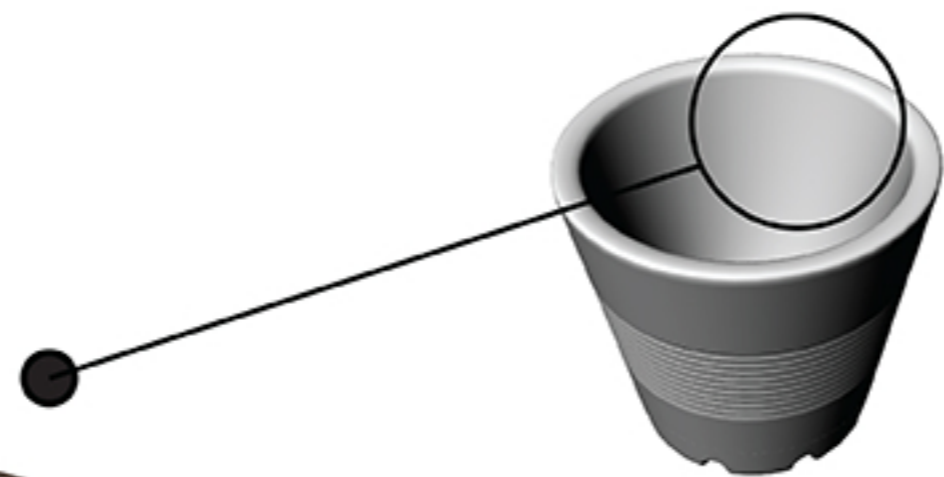
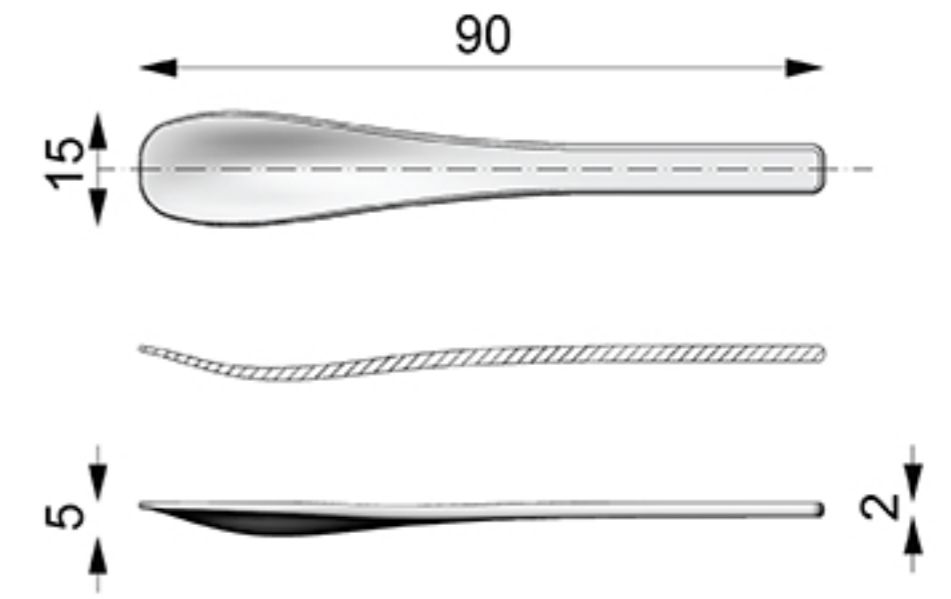

Apertura ridotta per garantire la formazione ed il mantenimento della crema, bordo spesso 5mm per il giusto feedback sulle labbra.

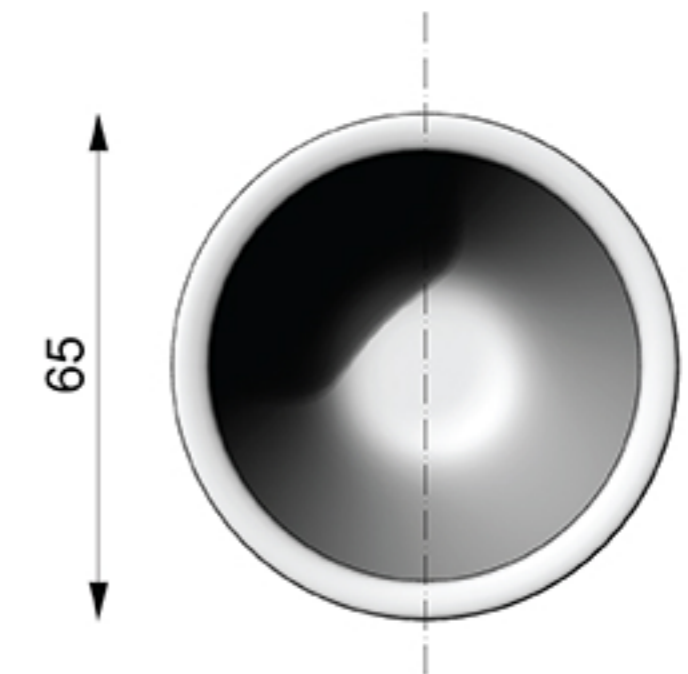

Area centrale sagomata per migliorare la presa.

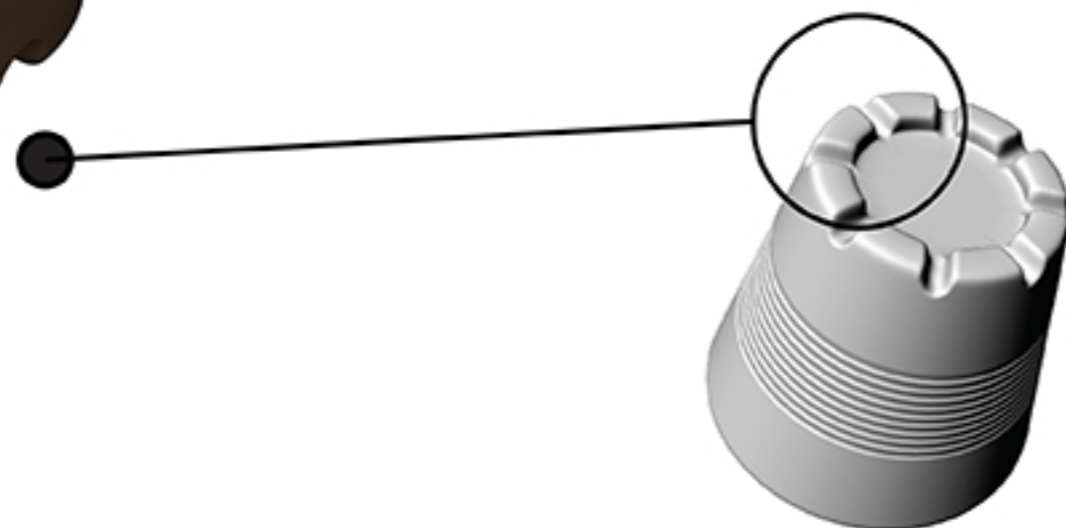
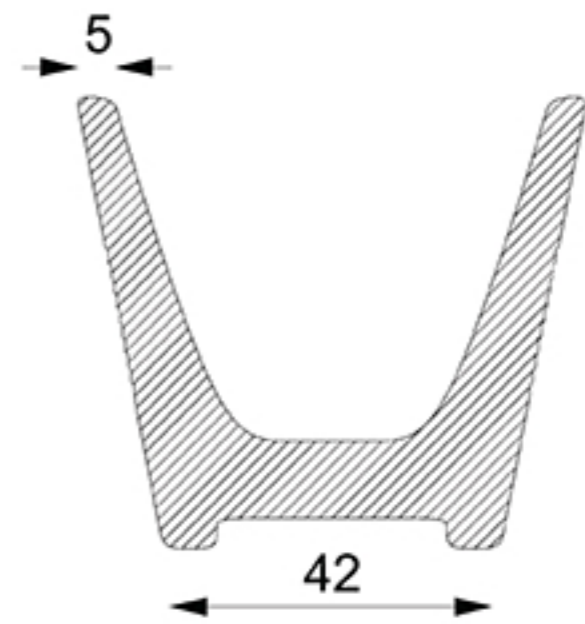

Le aperture sul fondo evitano il ristagno dell'acqua dopo il lavaggio.

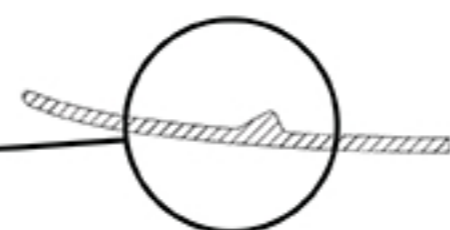

Concavità per accogliere la tazzina, il cucchiaino e l'eventuale bustina di zucchero.

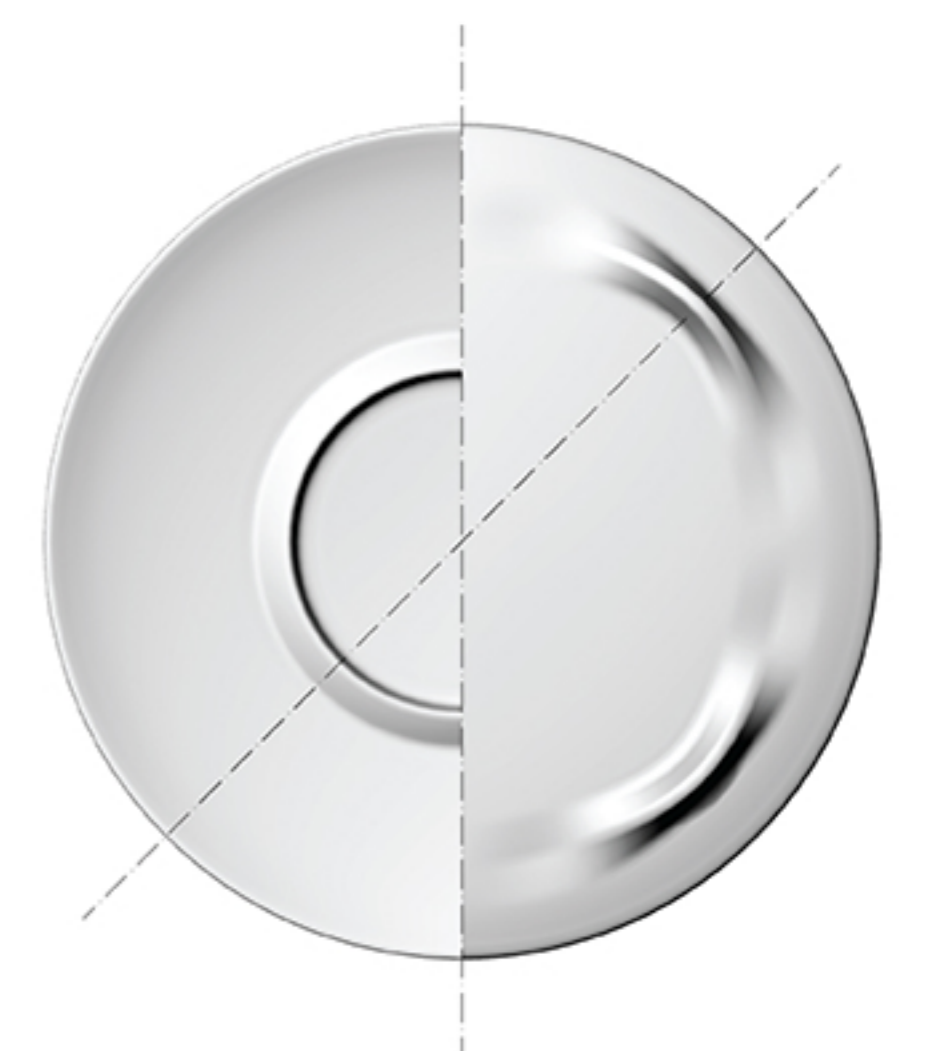
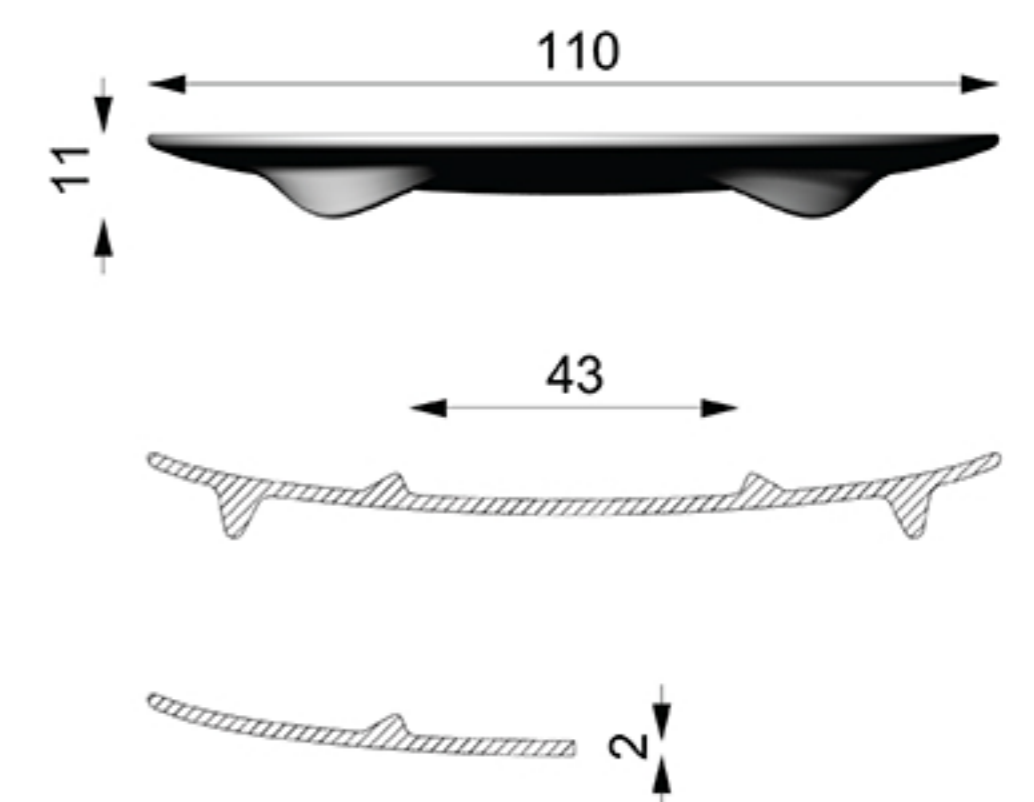



# Bioplastica da fondi di caffè

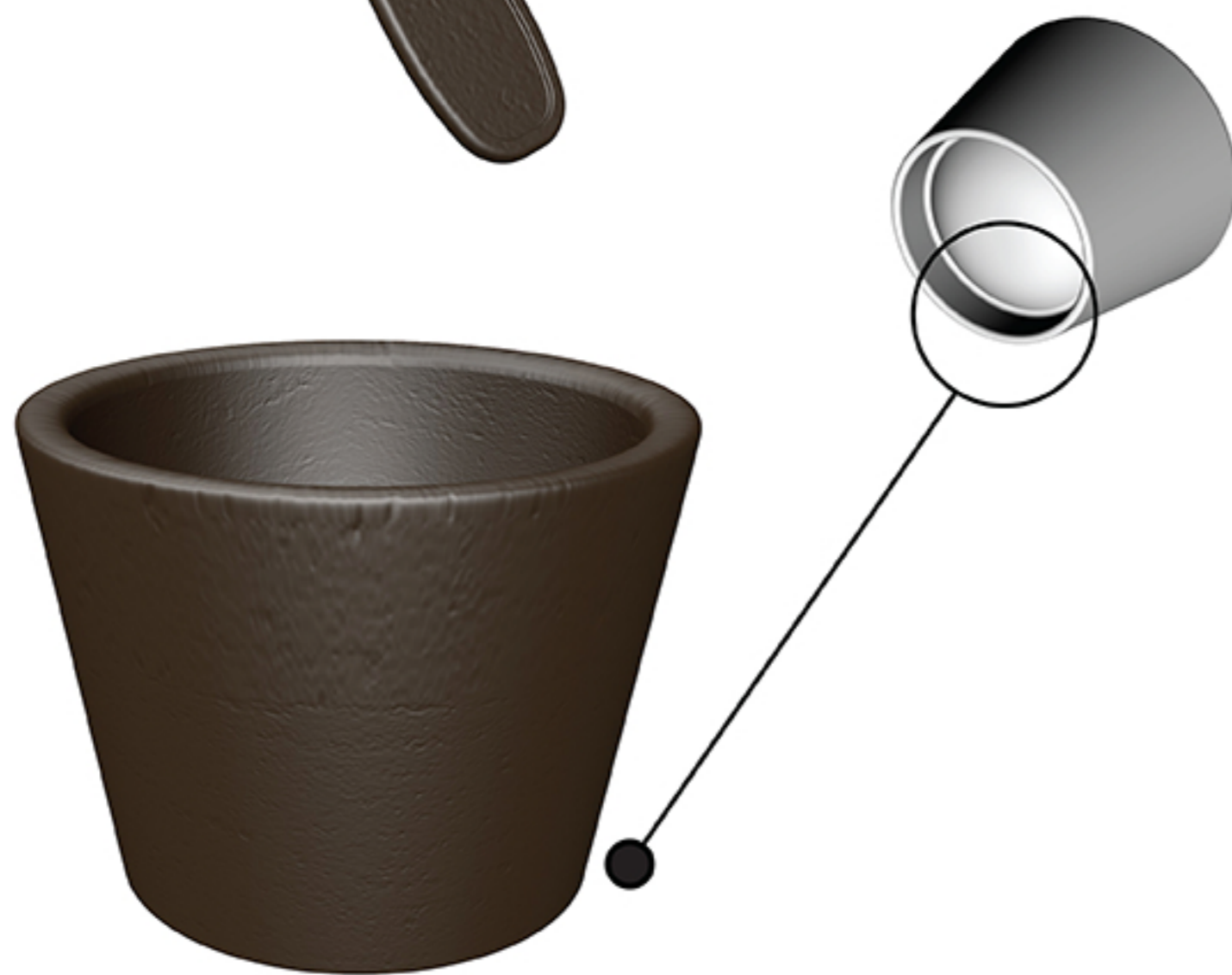
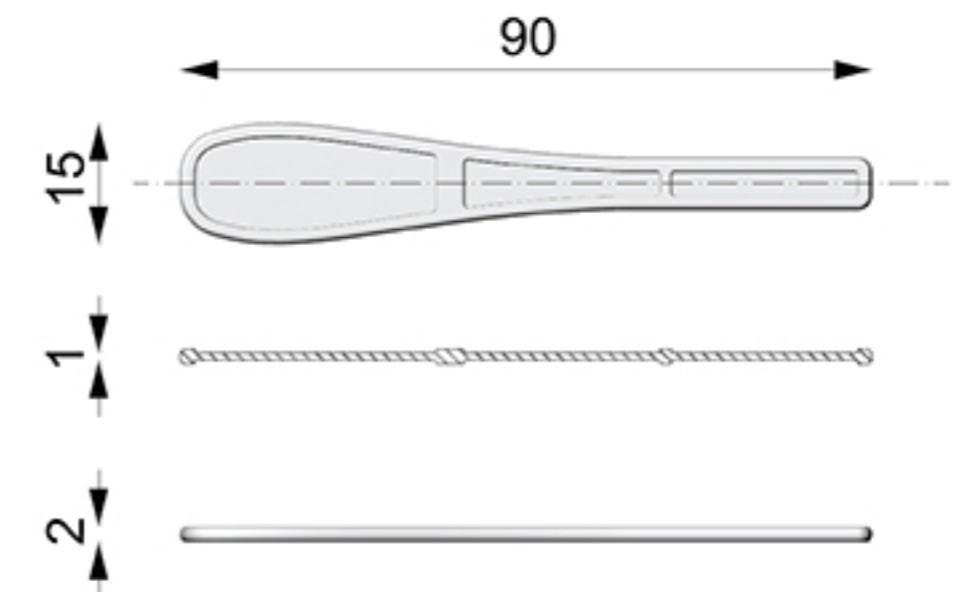

Fondo scavato per non sprecare materiale.

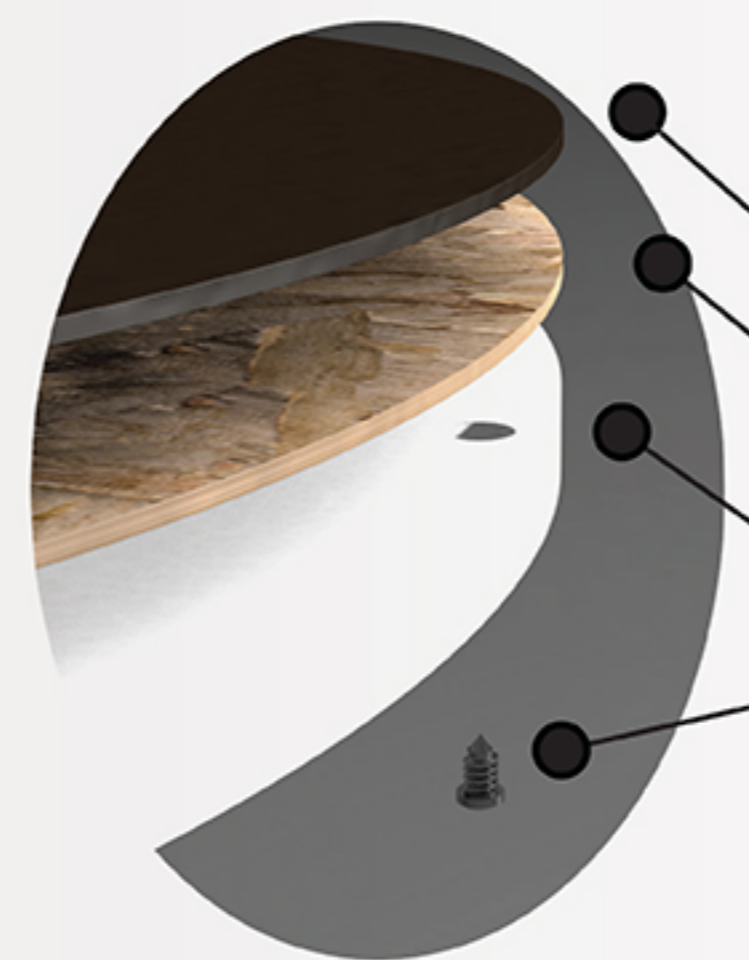
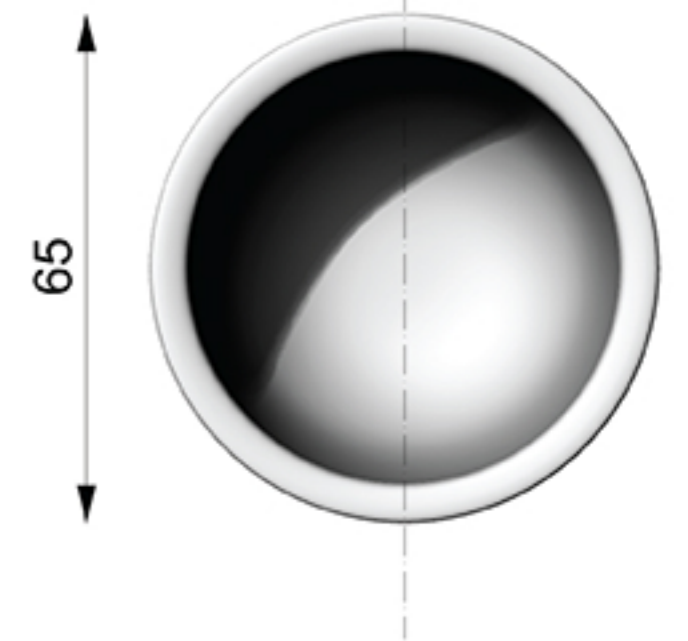
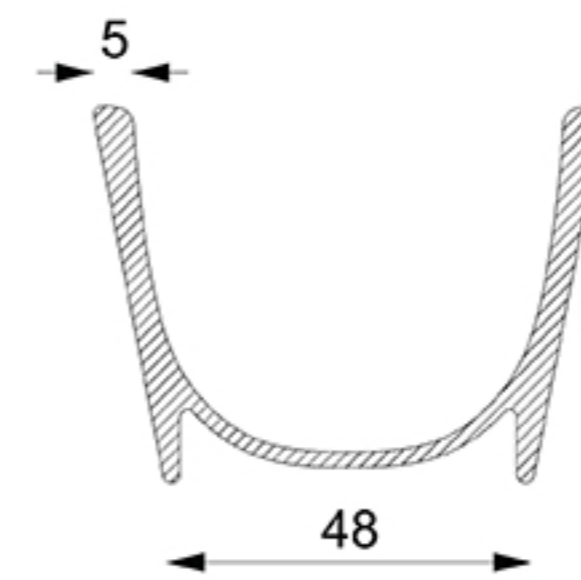

La possibilità di creare pannelli con questa bioplastica la rende ideale come rivestimento per complementi d'arredo, in sostituzione di materiali come la formica.

- Bioplastica sovrastampata
- Strato di compensato o altro legno di bassa qualità
- Complemento d'arredo
- Vite di fissaggio